

# SEAMOX<sup>®</sup>

Proudly Serving the Seamless Gutter Industry Since 1972



## 2020 Product Catalog

# PAINT & METAL SELECTION

Backed By Senox's 50 Year Paint Warranty

## TRADITIONAL PAINTED ALUMINUM

Factory Baked Finish • Flexible for Roll Forming • Exterior Durability



001 - 30° White



002 - Royal Brown



003 - Antique Ivory



004 - Black



005 - Raffia Beige

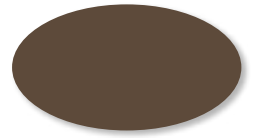

006 - Beaver Brown



007 - Classic Cream



008 - Clay

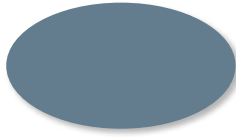

009 - Colonial Blue

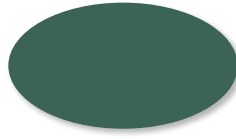

010 - Sherwood Green

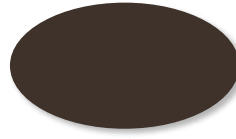

011 - Musket Brown



013 - Wicker



014 - Dove Gray



015 - Almond



017 - Linen

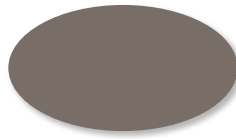

018 - Light Bronze

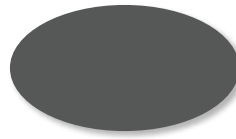

019 - Tuxedo Gray



020 - Heritage Cream

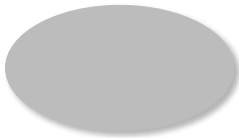

021 - Colonial Gray

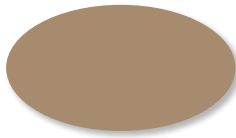

022 - Buckskin Brown



023 - 80° White



024 - Colonial Red



025 - Dark Bronze

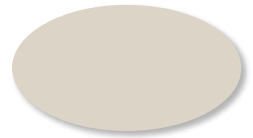

026 - Herringbone

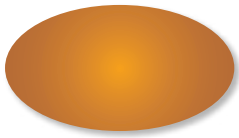

027 - Copper Metallic



028 - Paint Grip Metallic

\*Colors shown may vary from actual material\*

## ArmerTOUGH PAINTED ALUMINUM

Exclusive Product • Abrasion Resistant • Reduces Appearance of Staining



130 - Satin White

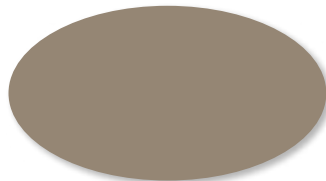

131 - Wood Beige



132 - Cameo

## DuelTone® PAINTED ALUMINUM

Created Through a Specialized Two-Coat Process  
High Performance Exterior Finish



129 - Rustic Copper

## PREMIUM METALS

3/4 Hard 16 oz. Copper  
26 ga. Galvalume Plus Steel

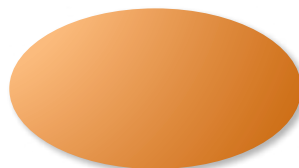

890 - Solid Copper



920 - Galvalume Plus Steel

**ShadowBAK**  
wash coat®  
Non-Reflective Disappearing Wash Coat



**Found on the Interior of Senox Painted Aluminum Gutters**

ShadowBAK® is a washcoat specially formulated by Senox that gives the inside of the gutter a non-reflective finish. The anodized bronze appearance provides the vanishing properties of a black shadow and erases the transition lines from the gutter to the roof.

# TABLE OF CONTENTS

---

<b>COIL</b> Seamless Gutter Coil	<b>p.4</b>	<b>PAINT &amp; SEALANT</b> Touch-Up Paint Sealant - Nitrile Rubber Base Sealant - Tripolymer Base Sealant - SBR Rubber Base	<b>p.18</b>
<b>GUTTER</b> End Caps for K-Style Miters for K-Style  Outlets for Flat Bottom Gutter Black MAX® Punch Paks for Flat Bottom Gutter Black MAX® Mini Punch Paks for Flat Bottom Gutter Black MAX® Punch Replacement Accessories  Flashing 16 oz. Solid Copper Flat Sheets Gutter Wedges for K-Style	<b>p.4</b>  <b>p.5</b>  <b>p.6</b>	<b>TOOLS</b> Aviation Snips Offset Snips Regular Pattern Snips Straight Snips Circular "Duckbill" Snips Combination Snips End Cap Crimpers Downspout Crimpers  Hand Seamers Drivers, Leveling & Caulking Cutting & Drilling  Ladder Accessories Miscellaneous Accessories Joints	<b>p.19</b>
<b>DOWNSPOUT</b> Rectangular Downspouts Rectangular Elbows Rectangular Offsets  Round Downspouts Round Elbows Round Offsets  Downspout Drive, Rack, & Key Downspout Hangers	<b>p.7</b>  <b>p.8</b>  <b>p.9</b>	<b>RAIN CHAINS</b> Rain Chains	<b>p.20</b>  <b>p.21</b>  <b>p.22</b>
<b>K-STYLE HANGERS</b> K-Style Internal Hangers	<b>p.10</b>	<b>CONDUCTOR HEADS</b> Conductor Heads Special Order Accessories	<b>p.23</b>
<b>HALF ROUND GUTTER</b> Reverse Bead Half Round Gutter Sections End Caps for Half Round Miters for Half Round Outlets for Half Round Black MAX® Mini Punch Pak for Half Round Gutter Wedges for Reverse Bead Half Round  Reverse Bead Half Round Internal Hangers Half Round External Hangers	<b>p.12</b>  <b>p.13</b>	<b>GUTTER MACHINES</b> Barracuda® Gutter Machines Barracuda® Gutter Machine Options  Senox Licensed Products	<b>p.24</b>  <b>p.25</b>
<b>GUTTER GUARDS</b> Aluminum Expanded Wire Gutter Guard Powder Coated Expanded Wire Gutter Guard Perforated Gutter Guard  Stainless Steel Metal Mesh Gutter Guard Louvered Gutter Guard Solid Gutter Guard	<b>p.14</b>  <b>p.15</b>	<b>INDEX</b>	<b>p.27</b>
<b>DRAINAGE</b> Splash blocks FLEX-Drain® Underground Drainage & Adaptors Universal Drainage & Adaptors	<b>p.16</b>		
<b>FASTENERS</b> Rivets #42 x 1/8" #8 Screws Senox SpeedMaster™ Screws Nails, Drive Pins, & Anchors	<b>p.17</b>		



Serving the Seamless Gutter Industry Since 1972

## **LARGEST INVENTORY IN-STOCK**

- Complete 5" & 6" K-Style and 6" Half Round product lines
- Dependable order fulfillment & delivery

## **COMPREHENSIVE COLOR SELECTION**

- 26 Painted aluminum colors, galvalume plus steel, & solid copper
- 3 Exclusive Armor Tough® painted aluminum colors
- Exclusive Duel Tone painted aluminum color
- All backed by Senox's 50 year paint warranty

## **GUTTER ACCESSORIES**

- Hidden hangers and half round internal & external hangers
- Outlets, offsets, miters, conductor heads, rain barrels, & more

## **HIGHEST QUALITY PRODUCTS**

- State-of-the-art manufacturing equipment ensures products are of the highest quality
- Senox manufactured products are made in North America

## **SUPERIOR PACKAGING**

- High grade cardboard used for all boxes
- Packaging specific to each product, no excess space for product to shift
- Boxes are sealed using staples vs. tape

- GUTTER MACHINES** • Comprehensive gutter machine service
- 3 Year parts & 1 year electrical warranty on all Senox gutter machines

*"We service the seamless gutter industry. That's all we do. If it has to do with gutters, we're either doing it, thinking about doing it, or planning to do it. We're thinking about gutters all the time."*

*—A.B. Walters, Founder/President*



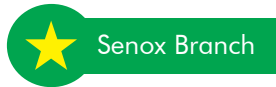

## SENOX BRANCH LOCATIONS

### E-COMMERCE

www.SenoxOnline.com  
Ph: 800-722-6958  
Fax: 888-804-4035

### REGION 1

#### AUSTIN

12112 Boardwalk Dr. STE-B  
Austin, TX 78729  
Ph: 512-582-1331  
Fax: 512-582-1333

#### DALLAS

12925 Valley Branch Ln.  
Farmers Branch, TX 75234  
Ph: 972-243-7272  
Fax: 972-243-7273

#### FORT WORTH

5204-D Airport Fwy.  
Fort Worth, TX 76117  
Ph: 817-831-4900  
Fax: 817-831-4901

#### GARLAND

3301 Wood Dr Ste #400  
Garland, TX 75041  
Ph: 469-573-2233  
Fax: 469-573-2204

#### HOUSTON CENTRAL

4466 W 12th St.  
Houston, TX 77055  
Ph: 713-316-9802  
Fax: 713-316-9807

#### HOUSTON NORTH

100 Northpark Central Dr.  
#400  
Houston, TX 77073  
Ph: 281-443-0420  
Fax: 281-443-0490

#### LONGVIEW

808-B Jordan Valley Rd.  
Longview, TX 75604  
Ph: 903-295-9555  
Fax: 903-295-9797

#### OKLAHOMA CITY

1340 Metropolitan Ave.  
Oklahoma City, OK 73108  
Ph: 405-948-7464  
Fax: 405-948-6287

#### SAN ANTONIO

3816 Binz-Engelman Rd.  
B-111  
San Antonio, TX 78218  
Ph: 210-514-1173  
Fax: 210-514-1175

### REGION 2

#### CHATTANOOGA

3475-C 8th Ave.  
Chattanooga, TN 37407  
Ph: 423-698-0050  
Fax: 423-698-3146

#### CLARKSTON

735 Park North Blvd. #106  
Clarkston, GA 30021  
Ph: 404-292-6181  
Fax: 404-292-6521

#### FULTON

555-C Wharton Circle  
Atlanta, GA 30336  
Ph: 404-691-9400  
Fax: 404-691-0094

#### KENNESAW

3690 Kennesaw S. Ind. Dr.  
Kennesaw, GA 30144  
Ph: 770-795-8500  
Fax: 770-795-9991

#### LOUISVILLE

4850 Crittenden Drive  
Suite 1A  
Louisville, KY 40209  
Ph: 502-324-1860  
Fax: 502-325-1300

#### NASHVILLE

302 Space Park Dr. S.  
Nashville, TN 37211  
Ph: 615-333-3383  
Fax: 615-333-3374

#### SUWANEE

2970 Shawnee Ridge Ct.  
#200  
Suwanee, GA 30024  
Ph: 770-476-4141  
Fax: 770-476-4175

### REGION 3

#### FORT MYERS

6361 Topaz Court  
Fort Meyers, FL 33966  
Ph: 239-217-6303  
Fax:

#### JACKSONVILLE

6858 Phillips Parkway Dr. S.  
Jacksonville, FL 32256  
Ph: 904-880-2192  
Fax: 904-880-7256

#### ORLANDO

473 Presidents Dr.  
Orlando, Florida 32809  
Ph: 407-734-2148  
Fax: 407-369-4229

#### PENSACOLA

3855 N Palafox St  
Pensacola, FL 32505  
Ph: 850-701-8192  
Fax: 850-303-2682

#### TAMPA

121-A Kelsey Ln.  
Tampa, Florida 33619  
Ph: 813-623-6178  
Fax: 813-626-1306

### REGION 4

#### CHARLOTTE

1419 Ameron Dr.  
Charlotte, NC 28206  
Ph: 704-371-5043  
Fax: 704-371-5077

## SEAMLESS GUTTER COIL

Senox seamless gutter coil is available in painted aluminum (all 26 traditional Senox colors), copper, or galvalume+ (all painted coil comes backed by our 50 year paint warranty.)



**11 7/8"**  
 .027" Aluminum  
 part # 111195XXX

**15"**  
 .027" Aluminum  
 part # 111505XXX

Available in: 26 Traditional, 1 Duel Tone®, 3 Armor Tough®

**11 7/8"**  
 .032" Aluminum  
 part # OS1111971XXX

**15"**  
 .032" Aluminum  
 part # OS1115071XXX

Available in: 26 Traditional, 1 Duel Tone®, 3 Armor Tough®

**11 7/8"**  
 16 oz. Solid Copper  
 part # 111195890

**15"**  
 16 oz. Solid Copper  
 part # 111505890

26 ga. Galvalume Plus Steel  
 part # 111195920

26 ga. Galvalume Plus Steel  
 part # 111505920

**18"**  
 .032" Aluminum  
 part # OS1118071XXX

**18"**  
 16 oz. Solid Copper  
 part # 111805890

26 ga. Galvalume Plus Steel  
 part # 111805920

## END CAPS FOR K-STYLE

Packaged 25R/25L Units/Box

Senox end caps provide a tap on fit to easily close the ends of the gutter; uses painted Senox coil to ensure a perfect match every time.

**5" Right or Left**  
 right - part # 221503XXX  
 left - part # 221505XXX

**6" Right or Left**  
 right - part # 221603XXX  
 left - part # 221605XXX

**7" Right or Left**  
 right - part # 221703XXX  
 left - part # 221705XXX

Available in: 26 Traditional, 1 Duel Tone® (129), 3 Armor Tough®, 16 oz. Solid Copper (890), 26 ga. Galvalume Plus Steel (920)

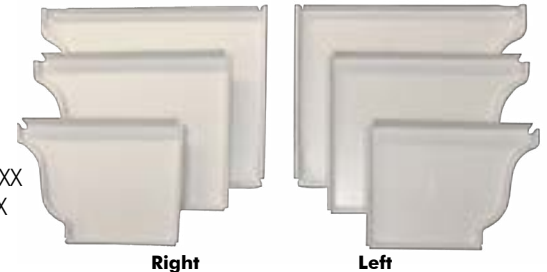

## MITERS FOR K-STYLE

Packaged 20 Units/Box

The fastest way to install corners, and available in the full range of Senox colors to perfectly match Senox gutters.

**5", 90°, Strip, O/S or I/S**  
 O/S - part # 231511XXX  
 I/S - part # 231513XXX

**6", 90°, Strip, O/S or I/S**  
 O/S - part # 231611XXX  
 I/S - part # 231613XXX

**7", 90°, Strip, O/S or I/S**  
 O/S - part # 231711XXX  
 I/S - part # 231713XXX

**5", 45°, Bay, O/S or I/S**  
 O/S - part # 231531XXX  
 I/S - part # 231533XXX

**6", 45°, Bay, O/S or I/S**  
 O/S - part # 231631XXX  
 I/S - part # 231633XXX

**7", 45°, Bay, O/S or I/S**  
 O/S - part # 231731XXX  
 I/S - part # 231733XXX

**5", 90°, Box, O/S or I/S**  
 O/S - part # 231561XXX  
 I/S - part # 231563XXX

**6", 90°, Box, O/S or I/S**  
 O/S - part # 231661XXX  
 I/S - part # 231663XXX

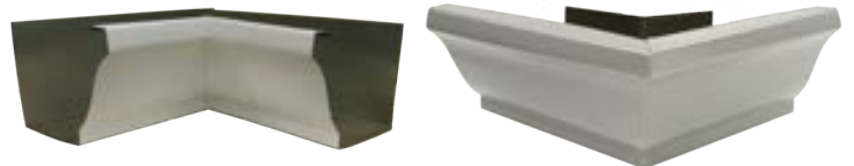

Available in: 26 Traditional, 1 Duel Tone®, 3 Armor Tough®, 16 oz. Solid Copper (890), 26 ga. Galvalume Plus Steel (920)

## COLOR SELECTION

### Traditional Painted Aluminum

- |                   |                    |                         |
|-------------------|--------------------|-------------------------|
| 001 30° White     | 010 Sherwood Green | 021 Colonial Gray       |
| 002 Royal Brown   | 011 Musket Brown   | 022 Buckskin Brown      |
| 003 Antique Ivory | 013 Wicker         | 023 80° White           |
| 004 Black         | 014 Dove Gray      | 024 Colonial Red        |
| 005 Raffia Beige  | 015 Almond         | 025 Dark Bronze         |
| 006 Beaver Brown  | 017 Linen          | 026 Herringbone         |
| 007 Classic Cream | 018 Light Bronze   | 027 Copper Metallic     |
| 008 Clay          | 019 Tuxedo Gray    | 028 Paint Grip Metallic |
| 009 Colonial Blue | 020 Heritage Cream |                         |

### Duel Tone® Painted Aluminum

- 129 Rustic Copper

### Armor Tough® Painted Aluminum

- 130 Satin White
- 131 Wood Beige
- 132 Cameo

### Metal Selection

- 099 Mill Finish Aluminum
- 870 Brass
- 890 Solid Copper
- 910 Galvanized Steel
- 920 Galvalume Plus Steel
- 968 Copper Plus

## OUTLETS FOR FLAT BOTTOM GUTTER

Senox outlets include an exclusive dimple for easy 'pop in' installation when used in tandem with our outlet punch- helps provide a snug fit when installing the outlet in the bottom of the gutter.

**2 3/8" Round**  
250 pcs/box  
part # 2612110004



Available in: Black (004)

**2 3/4" Round**  
250 pcs/box  
part # 2613110004



**3" Oval**  
100 pcs/box  
part # 263311XXXX



Available in: Black (004), Solid Copper (890), Galvanized Steel (910)

**4" Oval**  
50 pcs/box  
part # 263411XXXX



**2" x 3" Rectangle**  
100 pcs/box  
part # 2643110004



Available in: Black (004)

**3" x 4" Rectangle**  
50 pcs/box  
part # 2644120004



**4" x 5" Rectangle**  
50 pcs/box  
part # 2645140XXX



Available in: Aluminum (099), Solid Copper (890), Galvanized Steel (910)

## BLACK MAX® PUNCH PAKS FOR FLAT BOTTOM GUTTER

Everything you need to install the best gutter outlets anywhere; the Punch Pak includes Punch, 1 1/2" Hole Saw, 1/4" Driver Power Bit, and outlets- all for the same price as just ordering the outlets by themselves!

**2 3/8" Round**  
750 Outlets  
part # 2612119004

**2 3/4" Round**  
750 Outlets  
part # 2613119004

**2" x 3" Rectangle**  
900 Outlets  
part # 2643119004

**3" Oval**  
900 Outlets  
part # 2633119004

**4" Oval**  
450 Outlets  
part # 2634119004

**3" x 4" Rectangle**  
450 pcs/box  
part # 2644129004

Includes: Punch, 1 1/2" Hole Saw, 1/4" Driver Power Bit, Outlets



## BLACK MAX® MINI PUNCH PAKS FOR FLAT BOTTOM GUTTER

If you're just doing a job or two and don't need as many outlets as our standard Punch Pak, you need the Mini Punch Pak. Includes Punch, 1 1/2" Hole Saw, 1/4" Driver Power Bit, and outlets.

**2 3/8" Round**  
35 Outlets  
part # 2612118004

**2 3/4" Round**  
35 Outlets  
part # 2613118004

**2" x 3" Rectangle**  
100 Outlets  
part # 2643118004

**3" Oval**  
100 Outlets  
part # 2633118004

**4" Oval**  
50 Outlets  
part # 2634118004

**3" x 4" Rectangle**  
50 pcs/box  
part # 2644128004

Includes: Punch, 1 1/2" Hole Saw, 1/4" Driver Power Bit, Outlets



## BLACK MAX® PUNCH REPLACEMENT ACCESSORIES

**Hole Saw 1 1/2", for Punch**  
part # 8926928



**Driver Bit 1/4", for Punch**  
part # 8950812



**FLASHING**

*No fasteners needed; Senox Drip Caps help keep water from running behind the gutter, protecting your customer's roof.*

**Drip Cap**

30 pcs/box  
4' - part # 291812XXX



Available in: Black (004), 16 oz. Solid Copper (890),  
26 ga. Galvalume Plus Steel (920)

*Senox Drip Edges have the largest color selection in the marketplace today- available in all Senox colors.*

**Drip Edge, 1 1/2" x 1 1/2"**

30 pcs/box - Aluminum  
15 pcs/box - Copper, Steel  
10' - part # 291015XXX

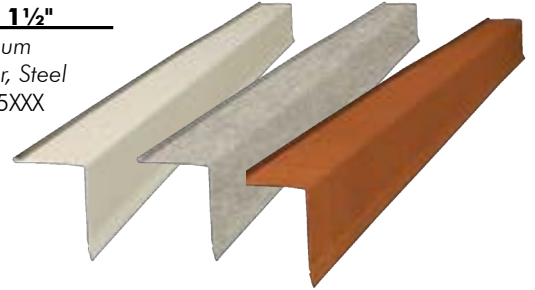

Available in: 26 Traditional, 1 Duel Tone®(129), 3 Armor Tough®,  
16 oz. Solid Copper (890), 26 ga. Galvalume Plus Steel (920)

**16 OZ. SOLID COPPER FLAT SHEETS**

**3' x 10'**

36 units/pallet  
part # 133655890



**GUTTER BUMPERS FOR K-STYLE**

*Compared to traditional gutter wedges, Senox Gutter Bumpers are faster & more cost effective- and with premarked lines, cutting accurately is easier than ever. All our bumpers feature ribs to provide extra strength and the SB bumper also fits 5", 6", & 7" K-Style gutters, unlike traditional wedges which you buy to size.*

**Gutter Bumper® SB**

100 pcs/box  
part # 2928150XXX

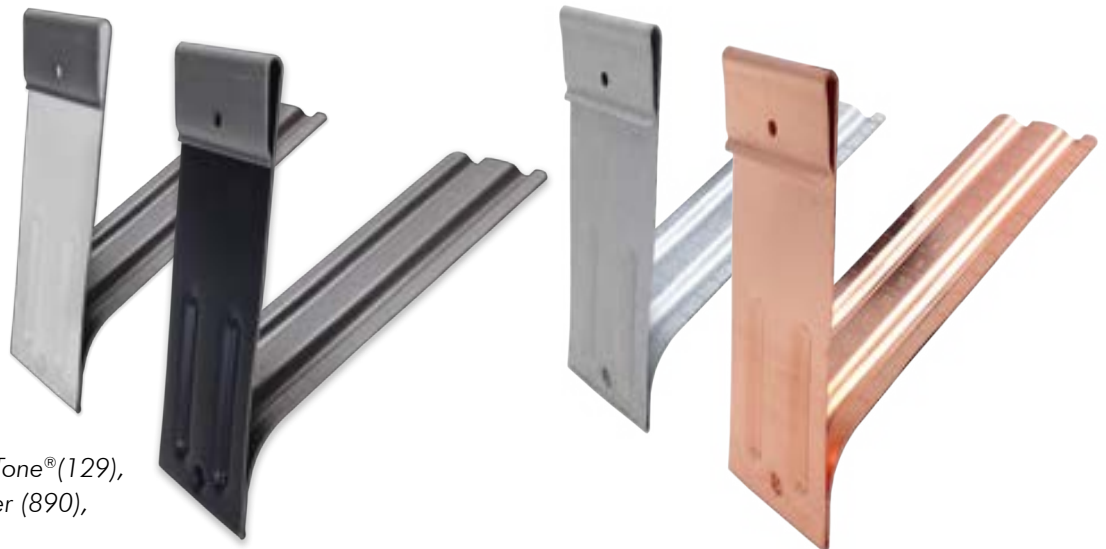

Available in: 26 Traditional, 1 Duel Tone®(129),  
3 Armor Tough®, 16 oz. Solid Copper (890),  
26 ga. Galvalume Plus Steel (920)

**For Straight Back  
Gutter**



## RECTANGULAR DOWNSPOUTS

Senox rectangular downspouts feature side crimp instead of the usual corner crimp, which allows for a cleaner transition.

### 2" x 3" x 8'

10 units/box  
part # 414324XXX

### 3" x 4" x 8'

10 units/box  
part #414424XXX

Available in: 26 Traditional, 1 Duel Tone®, 3 Armor Tough®

### 2" x 3" x 10'

10 units/box - Aluminum  
5 units/box - Copper & Steel  
part # 414325XXX

### 3" x 4" x 10'

10 units/box - Aluminum  
5 units/box - Copper & Steel  
part # 414425XXX

### 4" x 5" x 10'

6 units/box  
part # 414525XXX

Available in: 26 Traditional, 1 Duel Tone® (129), 3 Armor Tough®, 16 oz. Solid Copper (890), 26 ga. Galvalume Plus Steel (920)



## RECTANGULAR ELBOWS

### 2" x 3", A or B, 75°

36 pcs/box  
A - part # 424327XXX  
B - part # 424377XXX

### 3" x 4", A or B, 75°

20 pcs/box  
A - part # 424427XXX  
B - part # 424477XXX

### 4" x 5", A or B, 75°

12 pcs/box  
A - part # 424527XXX  
B - part # 424577XXX

### 2" x 3", A, 22.5°

72 pcs/box  
part # 424322XXX

### 3" x 4", A, 22.5°

40 pcs/box  
part # 424422XXX

### 4" x 5", A, 22.5°

12 pcs/box  
part # 424522XXX

### 2" x 3", A, 45°

42 pcs/box  
part # 424324XXX

### 3" x 4", A, 45°

30 pcs/box  
part # 424424XXX

### 4" x 5", A, 45°

12 pcs/box  
part # 424524XXX

Available in: 26 Traditional, 1 Duel Tone® (129), 3 Armor Tough®, 16 oz. Solid Copper (890), 26 ga. Galvalume Plus Steel (920)



## RECTANGULAR OFFSETS

### 2" x 3" x 2"

24 pcs/box  
part # 434322XXX

### 2" x 3" x 4"

24 pcs/box  
part # 434324XXX

### 2" x 3" x 6"

24 pcs/box  
part # 434326XXX

### 3" x 4" x 2"

15 pcs/box  
part # 434422XXX

### 3" x 4" x 4"

15 pcs/box  
part # 434424XXX

### 3" x 4" x 6"

15 pcs/box  
part # 434426XXX

Available in: 26 Traditional, 1 Duel Tone® (129), 3 Armor Tough®, 16 oz. Solid Copper (890), 26 ga. Galvalume Plus Steel (920)



### \*MADE TO ORDER\*

If you need a less common bend, we've got you covered!  
Custom bend elbows are available upon request.

### 2" x 3", A or B, 90°

36 pcs/box  
A - part # 424329XXX  
B - part # 424379XXX

### 3" x 4", A or B, 90°

18 pcs/box  
A - part # 424429XXX  
B - part # 424479XXX

### 2" x 3", B, 45°

42 pcs/box  
part # 424374XXX

### 3" x 4", B, 45°

25 pcs/box  
part # 424474XXX

Available in: 30° White (001)



**ROUND DOWNPOUTS**

**Packaged 5 Units/Box**

*Available in every Senox color, Senox round downspouts are the perfect compliment to our Half Round gutters (and offer a different option for K-Style gutters, too!)*

**3" x 10' Round**  
part # 415325XXX

**4" x 10' Round**  
part # 415425XXX

Available in: 26 Traditional, 1 Duel Tone® (129), 3 Armor Tough®,  
16 oz. Solid Copper (890), 26 ga. Galvalume Plus Steel (920)

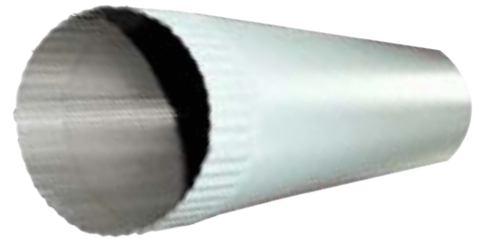

**ROUND ELBOWS**

**3" Round, 75°**  
10 units/box  
part # 425327XXX

**4" Round, 75°**  
10 units/box  
part # 425427XXX

**3" Round, 22.5°**  
12 units/box  
part # 425322XXX

**4" Round, 22.5°**  
12 units/box  
part # 425422XXX

**3" Round, 45°**  
12 units/box  
part # 425324XXX

**4" Round, 45°**  
10 units/box  
part # 425424XXX

Available in: 26 Traditional, 1 Duel Tone®, 3 Armor Tough®, 16 oz. Solid Copper, 26 ga. Galvalume Plus Steel

**3" Round, 90°**  
8 units/box  
part # 425329XXX

**4" Round, 90°**  
8 units/box  
part # 425429XXX

Available in: 30° White (001), 16 oz. Solid Copper (890), 26 ga. Galvalume Plus Steel (920)



**22.5°**



**45°**



**75°**

**ROUND OFFSETS**

**3" Round x 2"**  
6 pcs/box  
part # 435322XXX

**3" Round x 4"**  
6 pcs/box  
part # 435324XXX

**3" Round x 6"**  
4 pcs/box  
part # 435326XXX

**4" Round x 2"**  
4 pcs/box  
part # 435422XXX

**4" Round x 4"**  
4 pcs/box  
part # 435424XXX

**4" Round x 6"**  
4 pcs/box  
part # 435426XXX

Available in: 26 Traditional, 1 Duel Tone® (129), 3 Armor Tough®,  
16 oz. Solid Copper (890), 26 ga. Galvalume Plus Steel (920)



## DOWNSPOUT ACCESSORIES

### 2" Round Elbow

1 unit/box  
part # OS425237001



Available in: 30° White (001)

### Scupper

1 pcs/box  
part # 496770001



## DOWNSPOUT HANGERS

Available in all Senox colors, Quarter Moon hangers give a decorative finish to your downspout installations.

### Quarter Moon for Rectangular

For 2"X3" and 3"X4"  
100 units/box  
part # 454065XXX



### Quarter Moon for Round

For 3" and 4"  
100 units/box  
part # 454165XXX



Available in: 26 Traditional, 1 Duel Tone® (129), 3 Armor Tough®, 16 oz. Solid Copper (890), 26 ga. Galvalume Plus Steel (920)

### Concealed for Rectangular

For 2"X3" and 3"X4"  
100 units/box  
part # 453555XXX



Available in: 26 Traditional, 1 Duel Tone® (129), 3 Armor Tough®, 16 oz. Solid Copper (890), 26 ga. Galvalume Plus Steel (920)

## K-STYLE INTERNAL HANGERS

### **1600 Series for 5", 6"**

**Aluminum .060 with or without clip**

*Our most economical .060 robust hanger (but still built to Senox's high standards)*

100 pcs/box - Aluminum

5", no clip - part # 2416501099

5", w/clip - part # 2416531099

6", no clip - part # 2416601099

6", w/clip - part # 2416631099

Mini-barrels - Aluminum

5", no clip - 1000 pcs - part # 2416504099

5", w/clip - 1000 pcs - part # 2416534099

6", no clip - 500 pcs - part # 2416603099

6", w/clip - 500 pcs - part # 2416633099



### **1800 Series for 5", 6"**

**Aluminum .047 with or without clip**

*The most cost efficient way to eliminate gutter rattle*

100 pcs/box - Aluminum

5", no clip - part # 2418501099

5", w/clip - part # 2418531099

6", no clip - part # 2418601099

6", w/clip - part # 2418631099

Mini-barrels - Aluminum

5", no clip - 1000 pcs - part # 2418504099

5", w/clip - 1000 pcs - part # 2418534099

6", no clip - 500 pcs - part # 2418603099

6", w/clip - 500 pcs - part # 2418633099



### **2100 Series for 5", 6"**

**Aluminum .060 with or without clip**

*Our top seller! Senox's strongest hanger to come without a pre-loaded screw.*

100 pcs/box - Aluminum

5", no clip - part # 2421501099

5", w/clip - part # 2421531099

6", no clip - part # 2421601099

6", w/clip - part # 2421631099

Mini-barrels - Aluminum

5", no clip - 1000 pcs - part # 2421504099

5", w/clip - 1000 pcs - part # 2421534099

6", no clip - 500 pcs - part # 2421603099

6", w/clip - 500 pcs - part # 2421633099



### **2300 Series for 5", 6"**

**Aluminum .047 with or without clip**

**Copper and Galvalume+ .047 with or without clip**

*A wider hanger, comes with 3 pre-drilled holes (so breaking a screw is no big deal!)*

100 pcs/box - Aluminum, Solid Copper, Galvanized Steel

5", no clip - part # 2423501XXX

5", w/clip - part # 2423531XXX

6", no clip - part # 2423601XXX

6", w/clip - part # 2423631XXX

Mini-barrels - Aluminum

5", no clip - 500 pcs - part # 2423503099

5", w/clip - 500 pcs - part # 2423533099

6", no clip - 250 pcs - part # 2423602099

6", w/clip - 250 pcs - part # 2423632099



### **2800 Series for 5", 6"**

**Aluminum .047 with or without clip, #10 x 1.5" screw with T17 point, hi-low thread, 1000 hour black ruspert**

**Copper .050 with or without clip, #10 x 1.5" screw with T17 point, hi-low thread, stainless steel**

**Galv. Steel .047 with or without clip, #10 x 1.5" screw with T17 point, hi-low thread, 1000 hour black ruspert**

*Comes with Rattler™ front lip, and preloaded with 1.5" screw and washer for convenience.*

100 pcs/box - Aluminum, Solid Copper, Galvanized Steel

5", no clip - part # 2428501XXX

5", w/clip - part # 2428531XXX

6", no clip - part # 2428601XXX

6", w/clip - part # 2428631XXX

Mini-barrels - Aluminum

5", no clip, 500 pcs - part # 2428503099

5", w/clip, 500 pcs - part # 2428533099

6", no clip, 250 pcs - part # 2428602099

6", w/clip, 250 pcs - part # 2428632099



### **2900 Series for 5", 6"**

**Aluminum .047 with or without clip, #10 x 2" screw with T17 point, hi-low thread, 1000 hour black ruspert**

**Copper .050 with or without clip, #10 x 2" screw with T17 point, hi-low thread, stainless steel**

**Galv. Steel .047 with or without clip, #10 x 2" screw with T17 point, hi-low thread, 1000 hour black ruspert**

*Comes with Rattler® front lip, and preloaded with 2" screw for convenience.*

100 pcs/box - Aluminum, Solid Copper, Galvanized Steel

5", no clip - part # 2429501XXX

5", w/clip - part # 2429531XXX

6", no clip - part # 2429601XXX

6", w/clip - part # 2429631XXX

Mini-barrels - Aluminum

5", no clip, 500 pcs - part # 2429503099

5", w/clip, 500 pcs - part # 2429533099

6", no clip, 250 pcs - part # 2429602099

6", w/clip, 250 pcs - part # 2429632099



### **3400 Series for 5", 6"**

**Aluminum .047 with or without clip, #10 x 3" screw with T17 point, hi-low thread, 1000 hour black ruspert**

*Strong & Convenient, comes preloaded with 3" screw.*

100 pcs/box - Aluminum

5", no clip - part # 2434551099

5", w/clip - part # 2434571099

6", no clip - part # 2434651099

6", w/clip - part # 2434671099

Mini-barrels - Aluminum

5", no clip, 500 pcs - part # 2434553099

5", w/clip, 500 pcs - part # 2434573099

6", no clip, 250 pcs - part # 2434652099

6", w/clip, 250 pcs - part # 2434672099



## K-STYLE INTERNAL HANGERS

### **3600 Series for 5", 6"**

**Aluminum .047 with or without clip, #12 x 3" screw with T17 point, hi-low thread, 1000 hour black ruspert**

*Strong & Convenient, comes preloaded with #12 screw.*

- 100 pcs/box - Aluminum
- 5", no clip - part # 2436551099
- 5", w/clip - part # 2436571099
- 6", no clip - part # 2436651099
- 6", w/clip - part # 2436671099

- Mini-barrels - Aluminum
- 5", no clip, 500 pcs - part # 2433553099
- 5", w/clip, 500 pcs - part # 2433573099
- 6", no clip, 250 pcs - part # 2433652099
- 6", w/clip, 250 pcs - part # 2433672099



### **3800 Series for 5", 6"**

**Aluminum .047, wider, with or without clip, #12 x 3" screw with T17 point, hi-low thread, 1000 hour black ruspert**

*A more robust version of the 3600 hanger, comes preloaded with #12 screw.*

- 100 pcs/box - Aluminum, Solid Copper, Galvanized Steel
- 5", no clip - part # 2438551099
- 5", w/clip - part # 2438571XXX
- 6", no clip - part # 2438651099
- 6", w/clip - part # 2438671XXX



### **3800 Series for 7"**

**Copper .050, with or without clip, #12 x 3" screw with T17 point, hi-low thread, stainless steel**

**Galv. Steel .050, with or without clip, #12 x 3" screw with T17 point, hi-low thread, 1000 hour black ruspert**

*A more robust 7" version of the 3600 hanger, comes preloaded with #12 screw.*

- 100 pcs/box - Solid Copper, Galvanized Steel
- 7", no clip - part # 2438771XXX
- 7", w/clip - part # 2438771XXX



### **4000 Series for 5", 6"**

**Aluminum .055, with or without clip, #12 x 3.5" screw with T17 point, hi-low thread, 1000 hour black ruspert**

**Copper .050, with clip, #12 x 3.5" screw with T17 point, hi-low thread, stainless steel**

*Our strongest hanger, comes preloaded with #12 screw.*

- 100 pcs/box - Aluminum, Solid Copper
- 5", no clip - part # 2440551099
- 5", w/clip - part # 2440571099 | 2440571890
- 6", no clip - part # 2440651099 | 2440651890
- 6", w/clip - part # 2440671099 | 2440671890

- Mini-barrels - Aluminum
- 5", no clip, 500 pcs - part # 2440553099
- 5", w/clip, 500 pcs - part # 2440573099
- 6", no clip, 250 pcs - part # 2440652099
- 6", w/clip, 250 pcs - part # 2440672099



### **4200 Series for 7"**

**Aluminum .060, with or without clip, #12 x 3" screw with T17 point, twin lead thread, 1000 hour black ruspert**

*7", .060 thick version of the 3800 hanger- Strong & Convenient, comes preloaded with #12 screw.*

- 100 pcs/box - Aluminum
- 7", no clip - part # 2442761099
- 7", w/clip - part # 2442771099



### **9700 Series for 5", 6"**

- 100 pcs/box - Aluminum
- 5", Vampire, w/strap - part # OS-24-4151-1-099
- 6", Vampire, w/strap - part # OS-24-4161-1-099



### **9000 Series**

- 100 pcs/box - Aluminum, Solid Copper (890), Stainless Steel
- 10" T-Strap - part # 2499001XXX



**REVERSE BEAD HALF ROUND INTERNAL HANGERS**

**5000 Series for 6"HR**

**Aluminum .060 with or without clip**

100 pcs/box - Aluminum  
6", w/clip - part # 2450631099  
6", no clip - part # 2450611099



*Designed specifically for Half Round internal hangers, includes an extended wedge clip that sits against the fascia, preventing the gutter from tipping forward.*

**5100 Series w/ Wedge for 6"**

**Aluminum .060, with clip**

**Copper .050, with clip**

**Galvalume Plus .040, with clip**

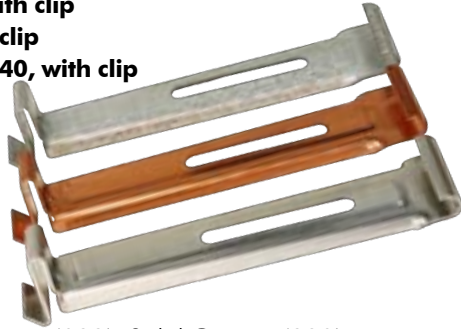

100 pcs/box  
part # 2451631XXX

Available in: Aluminum (099), Solid Copper (890), Galvalume Plus (920)

**5300 Series w/ Wedge for 6"**

**Aluminum .060, with or without clip, #12 x 3" screw with T17 point, hi-low thread, 1000 hour black ruspert**

**Copper .050, with or without clip, #12 x 3" screw with T17 point, hi-low thread, stainless steel**

**Galv. Steel .050, with or without clip, #12 x 3" screw with T17 point, hi-low thread, 1000 hour black ruspert**

100 pcs/box  
part # 2453661890



Available in: Aluminum (099), Solid Copper (890), Galvanized Steel (920)

**HALF ROUND EXTERNAL HANGERS**

**6" #10 Combo w/Spring**

50 pcs/box  
part # 255004XXX



Available in: White (001), Brown (002), Dark Bronze (025), Solid Copper (890), Galvanized Steel (920)

**6" Circle w/Spring, Nut, & Bolt**

50 pcs/box  
part # 255224XXX



**Extra Spring**

50 pcs/box  
part # 255226XXX



Available in: White (001), Brown (002), Dark Bronze (025), Brass (870), Galvanized Steel (920)

**#6 Shank for OG Crown Molding**

50 pcs/box  
part # 255106XXX



Available in: Solid Copper (890), Galvanized Steel (910)

**#25 Shank Sheeting 1/2 Pitch**

50 pcs/box  
part # 255115XXX

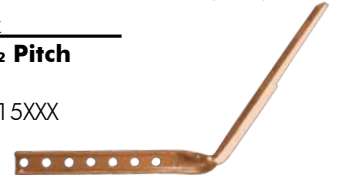

Available in: Solid Copper (890), Galvanized Steel (910)

**#11 Shank Exposed Rafter 1/3 Pitch**

50 units/box  
part # 255111XXX



Available in: White (001), Brown (002), Solid Copper (890), Galvanized Steel (910)

**#12 Shank Sheeting 1/3 Pitch**

50 pcs/box  
part # 255112XXX



**#30 Shank Adjustable Pitch w/Nut & Bolt**

50 pcs/box  
part # 255116XXX



Available in: White (001), Brown (002), Dark Bronze (025), Solid Copper (890), Galvanized Steel (910)

**5800 Series**

25 units/box  
part # 2558721XXX



Available in: 26 Traditional, 1 Duel Tone®(129), 3 Armor Tough®, 16 oz. Solid Copper (890), 26 ga. Galvalume Plus Steel (920)

**Extra Bolt w/Nut #10/24 x 3/4"**

50 units/box  
part # 255228XXX



Available in: Brass (870) Galvanized Steel (910)

**Wrap Around w/Strap for 6"**

50 units/box  
part # 2450631XXX



Available in: Solid Copper (890), Galvanized Steel (910)

**REVERSE BEAD HALF ROUND GUTTER SECTIONS**

Packaged 5 Units/Box

*Offer your customers specialty gutters without the investment of a dedicated half round machine.*



**6" x 10'**

part # 2166051890

Available in: 16 oz. Solid Copper

Available in: 26 Traditional, 1 Duel Tone® (129), 3 Armor Tough®, 16 oz. Solid Copper (890), 26 ga. Galvalume Plus Steel (910)

**END CAPS FOR HALF ROUND**

Packaged 25 Units/Box

**6" Right or Left**

right - part # 226603XXX

left - part # 226605XXX



Right



Left

Available in: 26 Traditional, 1 Duel Tone® (129), 3 Armor Tough®, 16 oz. Solid Copper (890), 26 ga. Galvalume Plus Steel (910)

**MITERS FOR HALF ROUND**

Packaged 20 Units/Box

**6", 90°, Strip, O/S or I/S**

O/S - part # 236611XXX

I/S - part # 236613XXX



**6", 45°, Bay, O/S or I/S**

O/S - part # 236631XXX

I/S - part # 236633XXX



Available in: 26 Traditional, 1 Duel Tone® (129), 3 Armor Tough®, 16 oz. Solid Copper (890), 26 ga. Galvalume Plus Steel (910)

**OUTLETS FOR HALF ROUND**

Packaged 50 Units/Box

**3" Round**

part # 265364XXX

Available in: White (001), Solid Copper (890), Galvanized Steel (910)



**4" Half Round**

part # 265444XXX

Available in: 30° White (001), Black (004), Solid Copper (890), Galvanized Steel (910)



**BLACK MAX® MINI PUNCH PAK FOR HALF ROUND**

*Everything you need to install half round outlets; the Mini Punch Pak includes Punch, 1 1/2" Hole Saw, 1/4" Driver Power Bit, and bulk savings on the outlets you need.*

**4" Half Round**

10 Outlets  
part # 2654448004

Includes: Punch, 1 1/2" Hole Saw, 1/4" Driver Power Bit, Outlets



**GUTTER WEDGES FOR REVERSE BEAD HALF ROUND**

**Gutter Bumper® HR**

100 pcs/box  
part # 2928660XXX

Available in: 30° White (001), Black (004), 16 oz. Solid Copper (890), 26 ga. Galvalume Plus Steel (910)

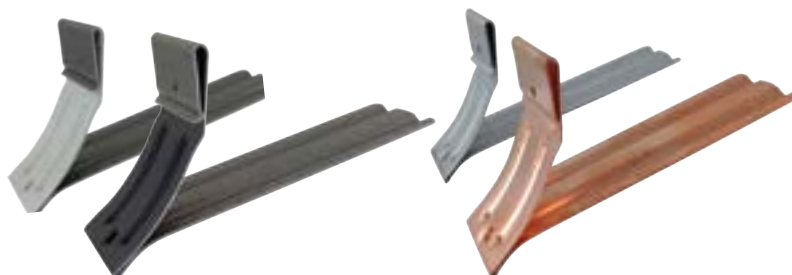

## ALUMINUM EXPANDED WIRE GUTTER GUARD

*Our most cost effective solution for keeping your customer's gutters debris-free.*

### **Drop-In**

4' pcs, 50 pcs/box  
5" - part # 381305099  
6" - part # 381306099

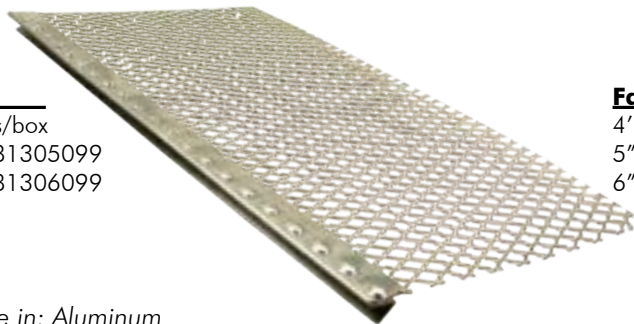

### **Fast Screen**

4' pcs, 50 pcs/box  
5" - part # 381505099  
6" - part # 381506099

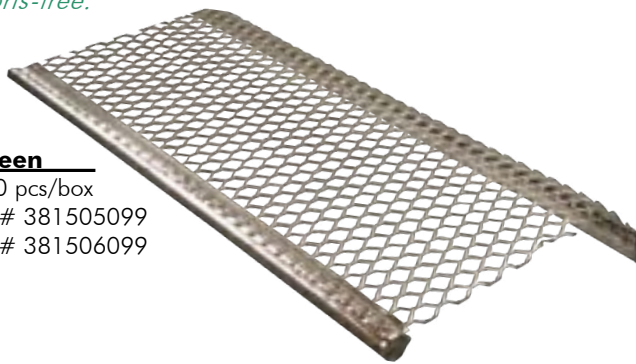

Available in: Aluminum

## POWDER COATED EXPANDED WIRE GUTTER GUARD

*Powder coated galvanized steel provides superior rust, rodent, and debris protection for decades to come.*

### **Roll Lock**

4' pcs, 25 pcs/box  
5" - part # 382105XXX  
6" - part # 382106XXX  
7" - part # 382107XXX

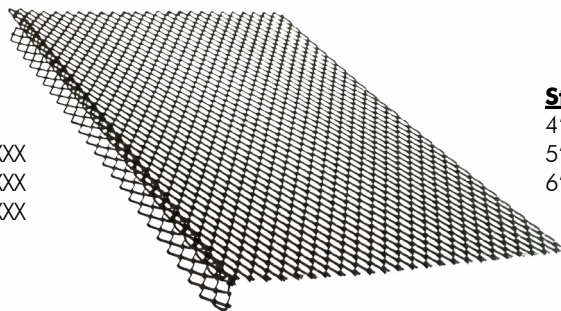

### **Step Lock**

4' pcs, 25 pcs/box  
5" - part # 382305XXX  
6" - part # 382306XXX

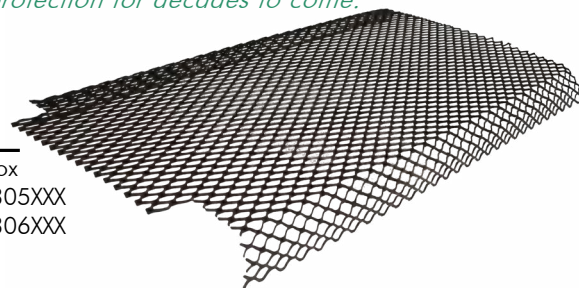

### **Flat Lock**

4' pcs, 25 pcs/box  
6" - part # 382506XXX  
7" - part # 382507XXX  
8" - part # 382508XXX  
9" - part # 382509XXX

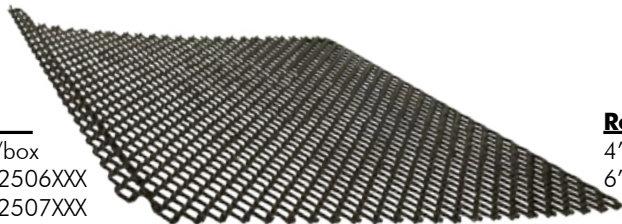

### **Round Lock for HR 6"**

4' pcs, 25 pcs/box  
6" - part # 382706XXX

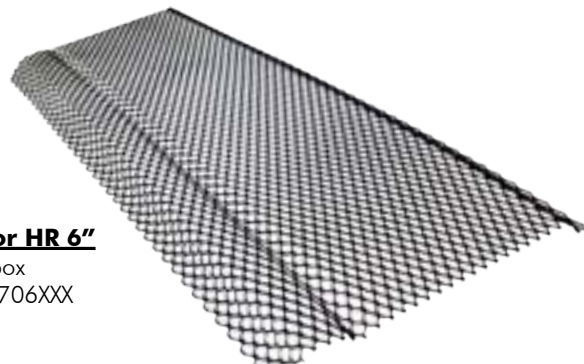

Available in: Black (004), Solid Copper (890)

## PERFORATED GUTTER GUARD

*Senox perforated gutter guards keep more debris from entering gutters and make cleaning them a breeze.*

### **Eave N Flow**

4' pcs, 50 pcs/box  
5" - part # 391405004  
6" - part # 391406004

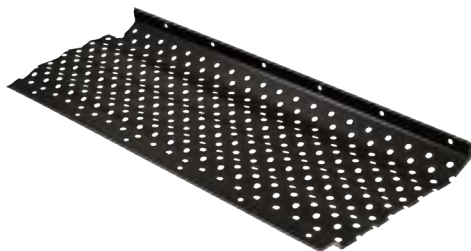

### **Smart Flow**

4' pcs, 50 pcs/box  
5" x 4' - part # 391400XXX  
6" x 4' - part # 391401XXX  
10' pcs, 25 pcs/box  
5" x 10' - part # 391410XXX  
6" x 10' - part # 391411XXX  
7" x 10' - part # 391412XXX



Available in: Black

Available in: White (001), Black (004)



## STAINLESS STEEL METAL MESH GUTTER GUARD

*For areas with fine debris like pine needles, metal mesh gutter guards provide the ultimate in debris protection.*

### Mesh Guard

4' pcs, 25 pcs/box  
5" - part # 393005004  
6" - part # 393006004

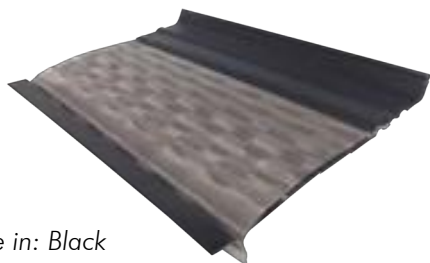

Available in: Black

### Mesh Guard Panel

4' pcs, 25 pcs/box  
part # 393105XXX

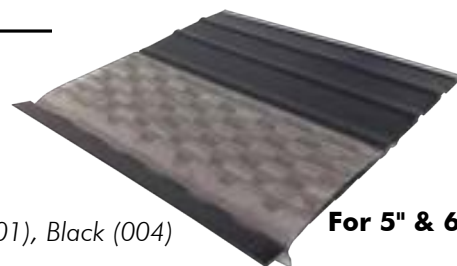

Available in: White (001), Black (004)

**For 5" & 6"**

## LOUVERED GUTTER GUARD

*Leaf protection that is as easy to install as it is to clean.*

### E-Z Leaf Sweep

4' pcs, 25 pcs/box  
5" - part # 392405XXX  
6" - part # 392406XXX

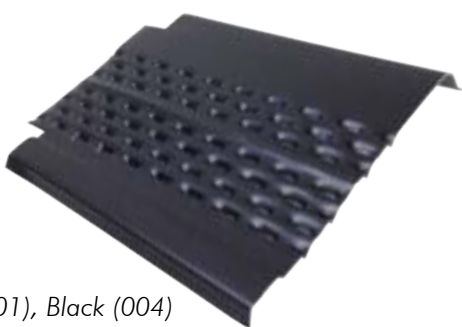

Available in: White (001), Black (004)

### E-Z Leaf Protection

4' pcs, 25 pcs/box  
part # 392505XXX



**For 5" & 6"**

## SOLID GUTTER GUARD

*Solid gutters guards use surface tension to direct water over the front and into the gutter. Unique patent pending gap system protects the gutter without clogging the outlets.*

### LeafFree

4' pcs, 25 pcs/box  
part # 395215XXX

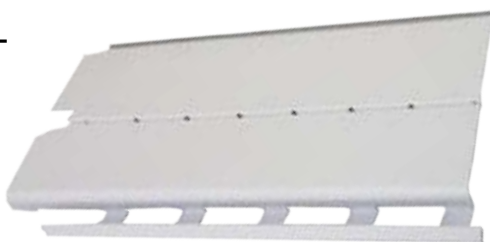

**For 5" & 6"**

### Leaffree High Water Flow

4' pcs, 5 pcs/box  
part # 395225XXX



**For 5" & 6"**

Available in: 30° White (001), Royal Brown (002), Antique Ivory (003), Black (004), Clay (008), Sherwood Green (010), Musket Brown (011), Wicker (013), Almond (015), Linen (017), Light Bronze (018), Tuxedo Gray (019), Heritage Cream (020), Colonial Gray (021), Colonial Red (024), Dark Bronze (025)

\*Solid Copper Special Order

### Midwest Solid

4' pcs, 25 pcs/box  
5" - part # 395015XXX  
6" - part # 395016XXX



Available in: 30° White (001), Royal Brown (002), Black (004), Clay (008), Wicker (013), Almond (015), Light Bronze (018), Colonial Gray (021)

### Berger Gutter Shingle

3' pcs, 20 pcs/box  
part # 395400004

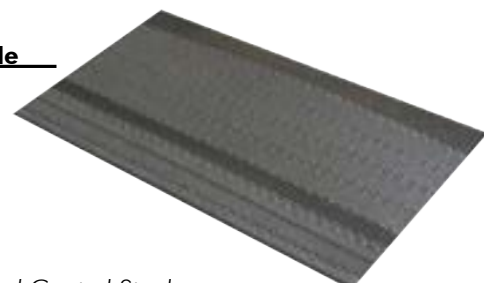

Available in: Galvanized Coated Steel

**For 5" & 6"**

**SPLASH BLOCKS**

**Plastic, Slate, 10" x 21"**

10 units/box

Gray - part # 612100014

Tan - part # 612100017



**Concrete, 11" x 18"**

80 units/pallet

Gray - part # 611115014



**Concrete, 12" x 12"**

100 units/pallet

Gray - part # 611110014



**FLEX-DRAIN® UNDERGROUND DRAINAGE & ADAPTORS**

Packaged 1 Unit/Box

**FLEX-Drain® 4" x 12' Perforated Pipe**

part # 622512004



**FLEX-Drain® 4" x 25' Solid Pipe**

part # 622516004



**FLEX-Drain® 4" Coupler**

part # 622520004



**FLEX-Drain® 4" Flexible T/Y**

part # 622525004



**FLEX-Drain® 2" x 3" x 4" Downspout Adapter**

part # 622522004



**FLEX-Drain® 3" x 4" x 4" Downspout Adapter**

part # 622524004



Available in: Black

**UNIVERSAL DRAINAGE & ADAPTORS**

Packaged 1 Unit/Box

**2" x 3" DS to 4" Universal**

part # 623022004



**3" x 4" DS to 4" Universal**

part # 623024004



Available in: Black

## RIVETS #42 X 1/8"

Packaged 100 Units/Box

A wide selection of colors are available to more effectively blend with Senox gutters.

### Aluminum, Painted

part # 521421XXX



### Steel, Zinc Plated

part # 521421905



### Solid Copper Barrel, Copper Plated Mandrel

part # 521421890



Available in: All Senox colors

## #8 SCREWS

### 1/4" Hex Head, 1/2" 1000 Hour Black Ruspert Coating

100 ct. - part # 511211XXX  
1000 ct. - part # 511212XXX



### 1/4" Hex Head 1/2" Zinc Plated

100 ct. - part # 511211905  
1000 ct. - part # 511212905



### 1/4" Hex Head 1/2" Copper Plated Stainless Steel

100 ct. - part # 511211967



Available in: All Senox colors

## SENOX SPEED MASTER® SCREWS

Senox Speed Master® screws are the only ones on the market specifically designed for gutter installation, coated with a long lasting black ruspert finish to better prevent corrosion.

Packaged 250 Units/Bag

### #10 x 1 1/2" No Washer, 1000 Hour Black Ruspert Coating

part # 513042904

### #10 x 1 1/2" With Washer, 1000 Hour Black Ruspert Coating

part # 513142904

### #10 x 2" No Washer, 1000 Hour Black Ruspert Coating

part # 513052904

### #10 x 2" With Washer, 1000 Hour Black Ruspert Coating

part # 513152904



Packaged 50 Units/Bag

### #10 x 1 1/2" With Washer Stainless Steel

part # 513142961

### #10 x 2" With Washer Stainless Steel

part # 513144961

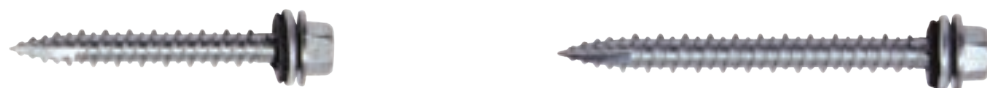

## NAILS, DRIVE PINS, & ANCHORS

### 1" Masonry Galvanized Steel

5 lb. - part # 531412910



### 1 1/2" Masonry Galvanized Steel

5 lb. - part # 531432910



### #10 1/4" Plastic Anchor

100 ct. - part # 541210099



**TOUCH-UP PAINT**

**Packaged 12 Units/Box**

**Brush-On Paint, 0.6 oz.**

part # 581006XXX

Available in: 26 Traditional,  
1 Duel Tone®, 3 Armor Tough®



**Spray-On Paint, 12 oz.**

part # 582160XXX

Available in: 26 Traditional, 3 Armor Tough®



**SEALANT - NITRILE RUBBER BASE**

**Packaged 24 Units/Box**

**Rusco PSCG, 1/10 Gallon**

part # 591141014



**Rusco PSCG-HV, 1/10 Gallon**

part # 591142014



**SEALANT - TRIPOLYMER BASE**

**Packaged 24 Units/Box**

**Geocel 2320, 1/10 Gallon**

part # 593320XXX



Available in: White, Gray, Clear

**Geocel 2321, 5 oz. Tube**

part # 593321001



Available in: White

**SEALANT - SBR RUBBER BASE**

**Packaged 24 Units/Box**

**OSI GS121, 1/10 Gallon**

part # 592121001



Available in: White

**AVIATION SNIPS**

**Max 2000, Left**  
part # 891M2001



**Max 2000, Right**  
part # 891M2002



**Max 2000, Straight**  
part # 891M2003



**OFFSET SNIPS**

**Max 2000, Left**  
part # 891M2006



**Max 2000, Right**  
part # 891M2007



**REGULAR PATTERN SNIPS**

**Regular Pattern Snips, 9"**  
part # 891M9



**STRAIGHT SNIPS**

**Straight Snips, 12"**  
part # 891M12N  
part # 891M12A



**Straight Snips, 14"**  
part # 891M14N  
part # 891M14A



**CIRCULAR "DUCKBILL" SNIPS**

**Circular "Duckbill" Snips, 10"**  
part # 891MD10

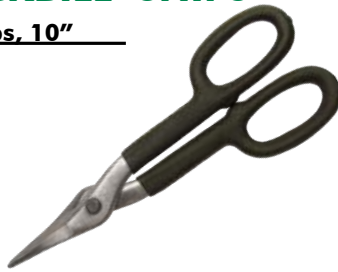

**Circular "Duckbill" Snips, 12"**  
part # 891MD12



**COMBINATION SNIPS**

**Combination Snips, 12"**  
part # 891MC12N  
part # 891MC12A



**Replacement Blade**  
part # 891MC12NRB  
part # 891MC12ARB

**Combination Snips, 14"**  
part # 891MC14N  
part # 891MC14A



**Replacement Blade**  
part # 891MC14NRB  
part # 891MC14ARB

**END CAP CRIMPERS**

**Snap Lock Punch**  
part # 894SL1R



**Adjustable Snap Lock Punch**  
part # 894SL2R



**DOWNPOUT CRIMPERS**

**Single Blade**  
part # 894SC1

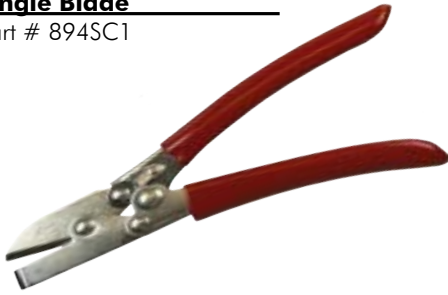

**3-Blade**  
part # 894SC3R



**5-Blade**  
part # 894C4R



**HAND SEAMERS**

**3"**  
part # 894S2R



**Offset, 3"**  
part # 894S3R



**6"**  
part # 894S6R



**Tool Replacement Spring**  
part # 8945018



**DRIVERS & LEVELING**

**Magnetic Bit Holder, 1/4"**  
part # 895MBH14



**Nut Driver Extension, 6"**  
part # 895BHE6



**Nut Driver, 1/4"**

- 1 3/4" - part # 895MSH14
- 2 9/16" - part # 895MSHL14
- 4" - part # 895MSHML14
- Malco 6" - part # 895MSHXL14
- 8" - part # 895MSHL148



**Torpedo Level, 9"**  
part # 898L9



**Hand Riveter, Economy**  
part # 896CR18



**Vampire T-Bar Tool**  
part # 89717232



**Caulking Gun**  
part # 898CG10

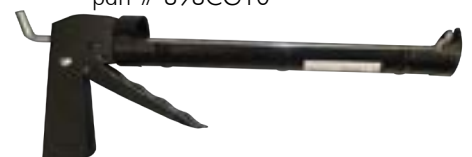

## CUTTING & DRILLING

### Hole Saw Pilot Bit

part # 892HSB



### Hole Saw 2 3/8"

part # 892H38



### Hole Saw 2 3/4"

part # 892H44



### ProTouch Combi-Saw

part # 892218HP300



### 12" 32 TPI Hacksaw Blade

part # 89220146V232HE



### Saw Blade Lubricant Stick

part # 899LUBS



### #30 Double Ended Bit 1/2"

part # 896NDE30



### Grease Crayon, White, .43 oz.

part # 899WLB2



## LADDER ACCESSORIES

### Ladder Max

part # 898162100



### Ladder Guards

part # 898165510



### Ladder Max Multi-Pro

part # 898162110



## MISCELLANEOUS ACCESSORIES

### Wasp Spray, 20 oz.

part # 899WASP



### Trough Mate

part # 898TM614



### Extension Cord, 50', 10 ga.

part # 898ECORD50



## JOINTS

### Expansion Joints for K-Style 5", 6"

1 unit/box

5" - part # 293305099

6" - part # 293306099

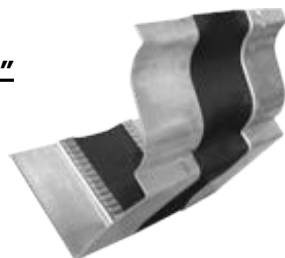

Available in: Aluminum

## RAIN CHAINS

### Hammered Cup

#### **Green Patina Copper**

part # 494021885

Available in: Solid Copper



SOLID COPPER

### Hammered Cup

#### **Painted Aluminum**

part # 494021XXX

Available: in Black (004), Dark Bronze (025)



BLACK



DARK BRONZE

### Gutter Reducer Adaptor

#### **Copper**

part # ON494111890

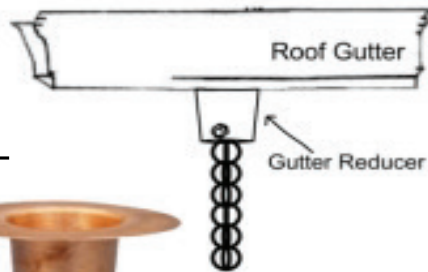

### Gutter Reducer Adaptor

#### **Aluminum**

part # 494111099

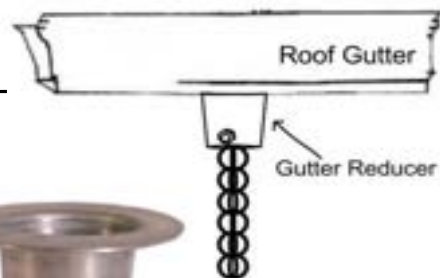



## CONDUCTOR HEADS

### Packaged 1 Unit/Box

Senox conductor heads are available in a wide variety of sizes and colors, to perfectly finish the job with no modifications needed.

#### Plain

2" x 3" & 3" x 4" Rectangle Outlet

2" x 3" - part # 441005XXX

3" x 4" - part # 441006XXX

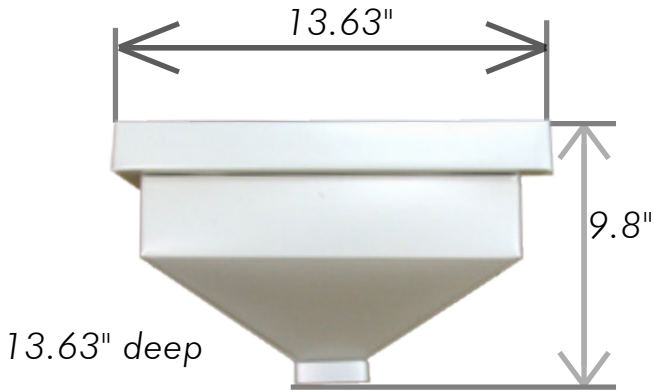

Available in: 30° White (001), 16 oz. Solid Copper (890), 26 ga. Galvalume Plus Steel (920)

#### Decorative

3" & 4" Oval Outlet

3" - part # 441201XXX

4" - part # 441203XXX

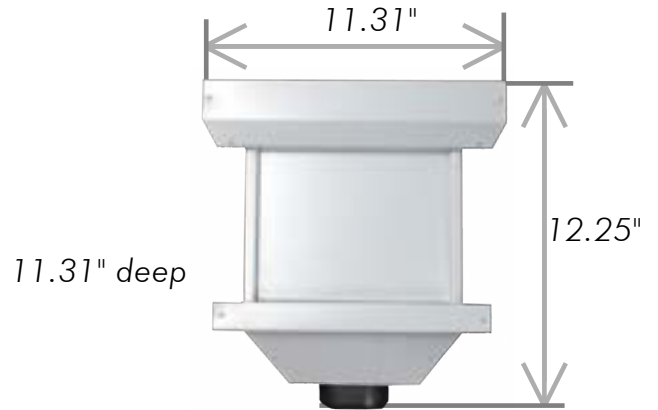

Available in: 26 Traditional, 1 Duel Tone® (129), 3 Armor Tough®, 16 oz. Solid Copper (890), 26 ga. Galvalume Plus Steel (920)

#### Ornamental

3" & 4" Round Outlet

3" - part # 442008XXX

4" - part # 442009XXX

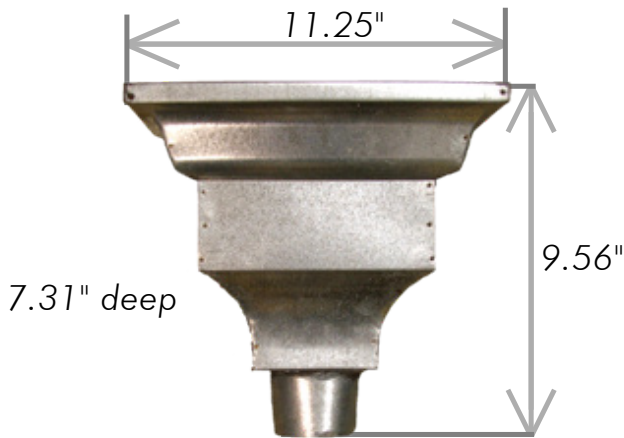

Available in: 16 oz. Solid Copper (890), 26 ga. Galvanized Steel (920)

#### Basic

4" Round Outlet

part # 441603001

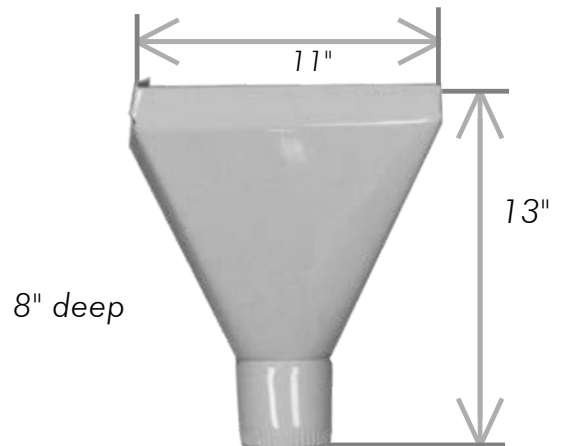

Available in: 30° White

**SENOX BARRACUDA® GUTTER MACHINES**

*A quality gutter machine is the cornerstone of all successful gutter businesses, and it is incredibly important to make sure you have a reliable machine that will do exactly what you need to satisfy your customers. Contact your Senox representative before purchasing to help match you with the perfect machine for you.*

**5" K-Style**  
6' 9" x 2' x 4'  
part # 81112001501

**5"/6" Combo K-Style**  
9' x 2' x 4'  
part # 81112001511

**6" K-Style**  
9' x 2' x 4'  
part # 81112001601

**6"/7" Combo K-Style**  
12' 7" x 2' x 4'  
part # 81112001621

**7" K-Style**  
12' 7" x 2' x 4'  
part # 81112001701

**6" Reverse Bead Half Round**  
14' x 2' x 4'  
part # 81112016601



\*Cradle not included with base machine

**SENOX BARRACUDA® GUTTER MACHINE OPTIONS**

*Everything you need to get the most out of your Barracuda® gutter machine.*

**Front Pull Guillotine**

**5" & 5"/6" Combo**  
part # 8111300151

**7" & 6"/7" Combo**  
part # 8111300172

**6" & 5"/6" Combo**  
part # 8111300161

**6" Half Round**  
part # 8111301660

**6" & 6"/7" Combo**  
part # 8111300162



**End Plate (No Shear)**

**5" & 6" & 5"/6" Combo**  
part # 8111350151

**7" & 6"/7" Combo**  
part # 8111350172

**6" Half Round**  
part # 8111351660



**Full Coil Cradle Machine Mount**

**5" & 6" & 5"/6" Combo**  
part # 811140151

**7" & 6"/7" Combo**  
part # 811140172

**6" Half Round**  
part # 811140660

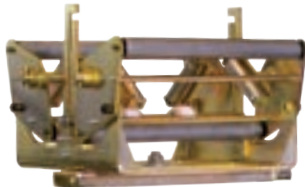

**Spin Coil Cradle Machine Mount**

**w/Single Scuff Bar & Side Roller Assembly**  
part # 811145151

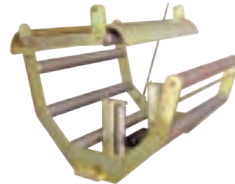

**Side Roller Assembly For Cradle**

part # 81904505



**Spool w/ Shaft**

**5" & 6" & 5"/6" Combo, 6" HR**  
part # 811160151

**7" & 6"/7" Combo**  
part # 811160172



**Upright Turnstile**

**5" & 6" & 5"/6" Combo**  
part # 811150151

**7" & 6"/7" Combo**  
part # 811150172

**6" Half Round**  
part # 811150660



**Transfer Bar Set**

**Fits All Sizes**  
part # 811165001

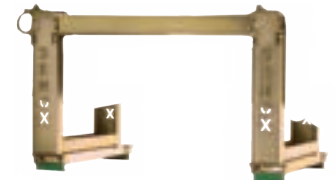

**Standard Run Out Stand w/ Adjustable Leg**

**5" & 6" & 5"/6" Combo, 6" HR**  
part # 811180100

**7" & 6"/7" Combo**  
part # 811180107



**Deluxe Run Out Stand w/ Adjustable Leg**

**5" & 6" & 5"/6" Combo, 6" HR**  
part # 811180130



**Machine Stand Riser Pad, Tall**

**Fits All Machines**  
part # 811190001



# SENOX<sup>®</sup>

## LICENSED PRODUCTS



### 5/6 Boxer

Depth: 20.02"  
 Width: 30.37"  
 Length: 124.24"  
 Weight: 1200 lbs (base machine)

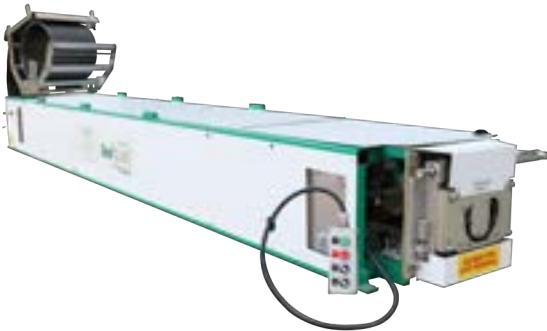

### 6.5 Half Round Wedger

Depth: 19"  
 Width: 24"  
 Length: 161"  
 Weight: 1574 lbs (base machine)



## AQUEDUCT INSTALLATION TOOL

### Installation Tool, 5"

part #8L354005

### Installation Tool, 6"

part #8L354006

### Installation Tool, 7"

part #8L354007

### Installation Tool, 6.5"

part #8L354065

## AQUEDUCT HANGERS

### For 5", 6", 6.5", and 7"

25 pcs/box

Screen Hanger, 5" x 4' - part # 3540050XXX

Screen Hanger, 6" x 4' - part # 3540060XXX

Screen Hanger, 7" x 4' - part # 3540070XXX

Screen Hanger, 6.5" x 4' - part # 3540650XXX

## AQUEDUCT MITERS

### For 5", 6", and 6.5"

20 pcs/box

Strip, 5", 90°, O/S & I/S- part # 334011961

Strip, 6", 90°, O/S & I/S- part # 334311961

Strip, 6.5", 90°, O/S & I/S- part # 334511961

Strip, 5", 45°, O/S & I/S- part # 334031961

Strip, 6", 45°, O/S & I/S- part # 334331961

Strip, 6.5", 45°, O/S & I/S- part # 334531961

## BEARCLAW HANGERS

### For 5", 6", for 6.5" HR

100 pcs/box - Aluminum

5", no clip, with screw - part # 3455501099

6", no clip, with screw - part # 3455601099

6.5" HR, with screw - part # 3455651099

## BEARCLAW GUTTER GUARD

### For 5", 6", and 6.5"

25 pcs/box

BearCLAW Expanded 5" x 4' - part # 383105XXX

BearCLAW Expanded 6" x 4' - part # 383106XXX

BearCLAW Expanded 6.5" x 4' HR-part # 383166XXX

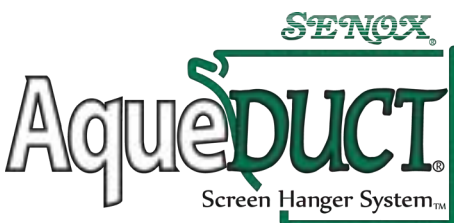

Available In:  
 5/6 Boxer  
 6.5 Half Round Wedger



Contact Clint Morgan 800-973-3102 for more information on Licensed Products

1. The front lip and associated hangers are available in K-Style (K-STYLE), Pocket Lock Lip (PLL), and Reverse Bead Half Round (RBHR).

2. The face and bottom are available in OG (OG), Flat Face (FF), and Half Round (HR).

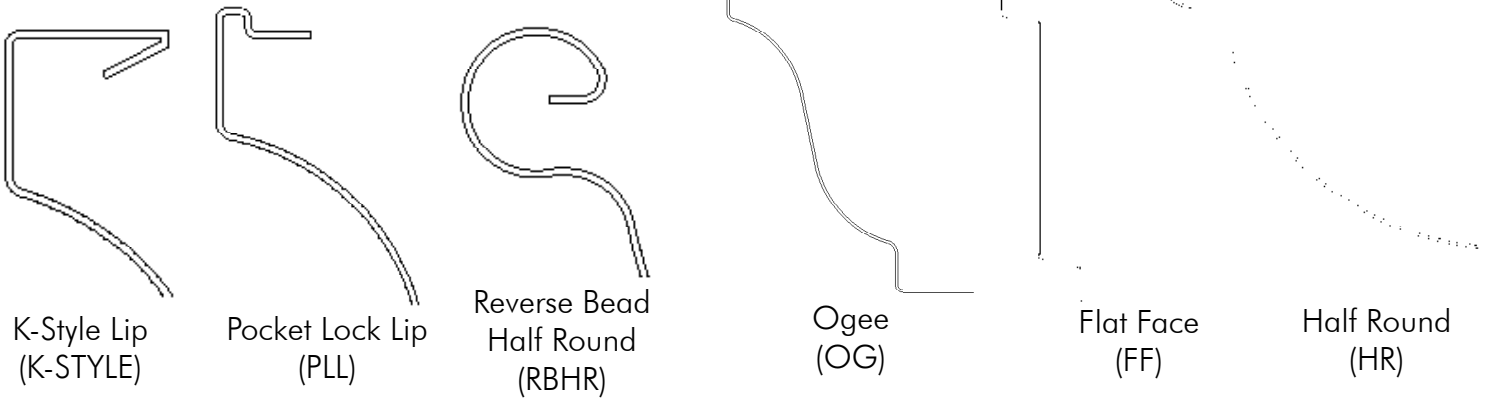

3. The back and gutter bumpers are available in Straight Back (SB), Straight Back High/Low (SBHL), Half Round Reverse Bead (HR), Half Round Wedger (HW), and Half Round High Back (HH).

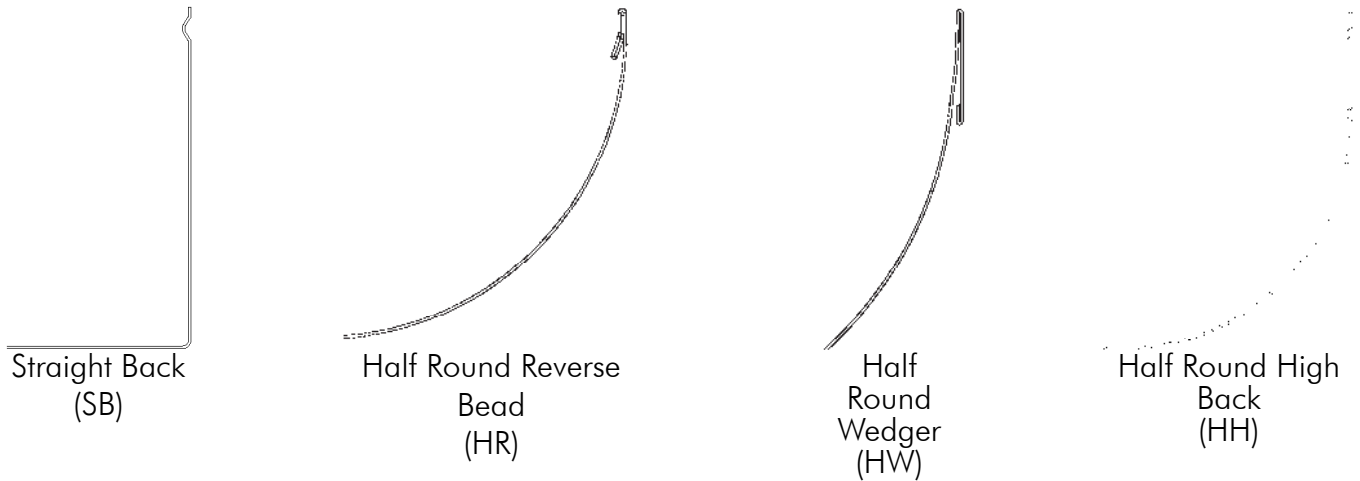

4. Gutterguards are available in K-Style, BearCLAW, AqueDUCT, and LeafLID.

The major discrepancy in everyone's mind is centered around OG vs. K-Style. Our opinion is OG speaks to the shape of the gutter face. This shape has been around since the Greeks. K-Style describes the hanger style and front lip design on the top of the OG shape. Over time the K-Style front lip and the OG shape have become synonymous in people's minds. Because of the new styles of front lips and hangers, this thinking needs to be separated to allow us to describe them separately. Our additional designs for the back of the gutter also call for more precise definitions.

—A.B. Walters  
President

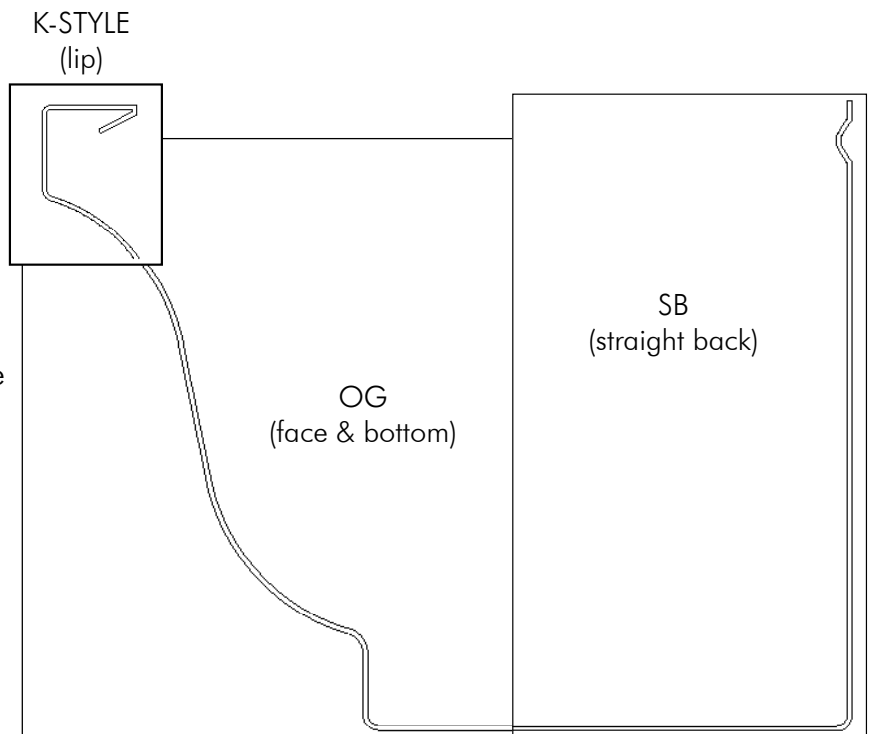

- A**
- Accessories, Downspout .....8
  - Accessories, Ladder .....21
  - Accessories, Miscellaneous .....21
  - Adaptors, Underground Drainage .....16
  - Anchors, Nails, & Drive Pins .....17
  - Aviation Snips .....19
- B**
- Bar w/ Rod for 6" .....13
  - Barracuda Gutter Machines, Senox .....24
  - Barracuda Gutter Machine Options, Senox .....24
  - Black MAX Punch Pak Flat Bottom Gutter .....5
  - Black MAX Mini Punch Pak Flat Bottom Gutter .....5
  - Black MAX Mini Punch Pak Half Round .....13
  - Black MAX Punch Replacement Accessories .....5
  - Blade, Hacksaw .....21
  - Bracket, 6" Cast .....23
  - Bolt w/ Nut .....12
- C**
- Cast Bracket, 6" .....23
  - Caulking, Drivers, & Leveling .....20
  - Circular "Duckbill" Snips .....19
  - Coil, Seamless Gutter .....4
  - Combination Snips .....19
  - Combi-Saw .....21
  - Conductor Heads .....23
  - Copper Flat Sheets, Solid .....6
  - Crimpers, Downspout .....20
  - Crimpers, End Cap .....20
  - Cutting & Drilling .....21
- D**
- Downspout Accessories .....9
  - Downspout Crimpers .....20
  - Downspout Hangers .....9
  - Downspouts, Rectangular .....7
  - Downspouts, Round .....8
  - Drainage & Adaptors .....16
  - Drilling & Cutting .....21
  - Drip Cap .....6
  - Drip Edge .....6
  - Drive Pins, Anchors, & Nails .....17
  - Drivers, Leveling, & Caulking .....20
  - Duckbill Snips, Circular .....19
- E**
- Elbows, Rectangular .....7
  - Elbows, Round .....8
  - End Cap Crimpers .....19
  - End Caps for Half Round .....13
  - End Caps for K-Style .....4
  - Expansion Joints for K-Style .....21
  - Extension Cord .....21
  - External Hangers, Half Round .....12
- F**
- Flashing .....6
  - Flat Sheets, Solid Copper .....6
  - FLEX-Drain Underground Drainage & Adaptors 16
- G**
- Grease Crayon .....21
  - Gutter Bumper HR .....13
  - Gutter Bumper SB .....6
  - Gutter Coil, Seamless .....4
  - Gutter Guard, Aluminum Expanded Wire .....14
  - Gutter Guard, Louvered .....15
  - Gutter Guard, Perforated .....14
  - Gutter Guard, Powder Coated Expanded Wire ...14
  - Gutter Guard, Solid .....15
  - Gutter Guard, Stainless Steel Metal Mesh .....15
  - Gutter Machine Options, Senox Barracuda .....24
  - Gutter Machines, Senox Barracuda .....24
  - Gutter Machines, Senox Licensed Products .....25
  - Gutter Sections, Reverse Bead Half Round .....13
  - Gutter Wedges for Reverse Bead Half Round .....13
- H**
- Hacksaw Blade .....21
  - Half Round External Hangers .....12
  - Half Round Gutter Sections, Reverse Bead .....13
  - Half Round Internal Hangers, Reverse Bead .....12
  - Half Round Miters .....13
  - Half Round Outlets .....13
  - Hand Riveters .....20
  - Hand Seamers .....20
  - Hangers, Downspout .....9
  - Hangers, K-Style Internal .....10-11
  - Hangers, Reverse Bead Half Round Internal .....12
  - Hangers, Half Round External .....12
  - Hole Saw 1 1/2", for Punch .....5
  - Hole Saw .....21
- I**
- Internal Hangers, Reverse Bead Half Round .....12
  - Internal Hangers, K-Style .....10-11
- J**
- Joints .....21
- K**
- K-Style Internal Hangers .....10-11
- L**
- Ladder Accessories .....21
  - Leveling, Caulking, & Drivers .....20
  - Licensed Products, Gutter Machines .....25
  - Lubricant, Saw Blade .....21
- M**
- Mini Punch Pak Flat Bottom Gutter, Black Max .....5
  - Mini Punch Pak Half Round, Black Max .....13
  - Miscellaneous Accessories .....21
  - Miters for Half Round .....13
  - Miters for K-Style .....4
- N**
- Nails, Drive Pins, & Anchors .....17
- O**
- Offsets, Rectangular .....7
  - Offsets, Round .....8
  - Offset Snips .....19
  - OSI Sealant .....18
  - Outlets for Flat Bottom Gutter .....5
  - Outlets for Half Round .....13
- P**
- Paint, Touch-Up .....18
  - Pipe Bands, Downspout Hangers .....9
  - Punch Pak Flat Bottom Gutter, Black MAX .....5
  - Punch Pak Flat Bottom Gutter, Black MAX Mini ..5
  - Punch Pak Half Round, Black MAX Mini .....13
  - Punch Replacement Accessories, Black MAX .....5
- R**
- Rain Chains .....22
  - Rectangular Downspouts .....7
  - Rectangular Elbows .....7
  - Rectangular Offsets .....7
  - Regular Pattern Snips .....19
  - Reverse Bead Half Round Gutter Sections .....13
  - Reverse Bead Half Round Internal Hangers .....12
  - Rivets, #42 x 1/8" .....17
  - Round Downspouts .....8
  - Round Elbows .....8
  - Round Offsets .....8
  - Rusco Sealants .....18
- S**
- Saw Blade Lubricant .....21
  - Screws, #8 .....17
  - Screws, SpeedMaster® .....17
  - Sealant, Nitrile Rubber Base .....18
  - Sealant, SBR Rubber Base .....18
  - Sealant, Tripolymer Base .....18
  - Seamers, Hand .....20
  - Seamless Gutter Coil .....4
  - Snips .....19
  - Solid Copper Flat Sheets .....6
  - Splash Blocks .....16
  - Straight Snips .....19
  - Stamped Bracket, 5800 Series .....12
- T**
- Touch-Up Paint .....18
  - T-Strap, 9000 Series .....11
  - Torpedo Level .....20
  - Trough Mate .....21
- U**
- Underground Drainage & Adaptors .....16
- W**
- Wedges for Reverse Bead Half Round, Gutter .13
  - Wrap Around w/Strap .....13







**Serving the Seamless Gutter Industry Since 1972**

15409 Long Vista Drive  
Austin, TX 78728

Phone: 866-522-1696  
Fax: 800-295-2702

[www.senox.com](http://www.senox.com)  
[senoxinfo@senox.com](mailto:senoxinfo@senox.com)